

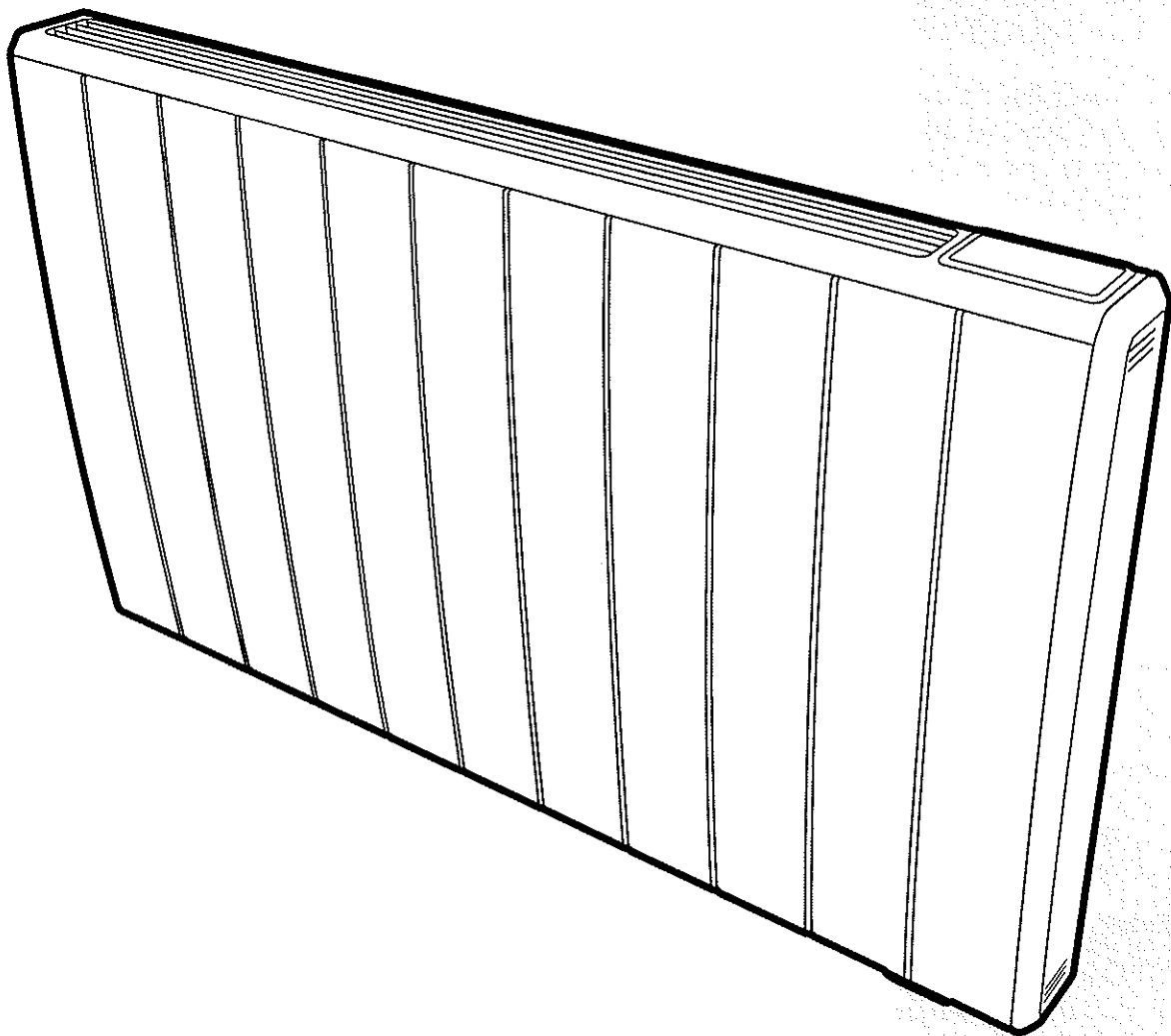

A world of expertise

OPERATING INSTRUCTIONS MANUAL



Q-Rad Electric Radiator

Models: QRAD050 / QRAD075 / QRAD100 / QRAD150 / QRAD200

These instructions should be read carefully and retained for future use. Note also the information presented on the appliance.



IMPORTANT

These instructions should be read carefully and retained for future use. Note also the information presented on the appliance.

IMPORTANT SAFETY ADVICE

When using electrical appliances, basic precautions should always be followed to reduce the risk of fire, electrical shock, and injury to persons, including the following:

IMPORTANT – The wall bracket supplied with the appliance must be used.

WARNING - DO NOT USE THIS HEATER IN THE IMMEDIATE SURROUNDINGS OF A BATH, A SHOWER OR A SWIMMING POOL.

IMPORTANT – If the heater is installed in a room containing a bath or shower, it must be so installed that switches and other controls cannot be touched by a person using a bath or shower.

Do not use outdoors.

Do not locate the heater immediately below a fixed socket outlet or connection box.

WARNING: In order to avoid overheating, do not cover the heater. Do not place material or garments on the heater, or obstruct the air circulation around the heater, for instance by curtains or furniture, as this could cause overheating and a fire risk.

NEVER cover or obstruct in any way the heat outlet slots at the top of the heater or the air inlet slots in the base of the heater.

The heater carries a warning 'DO NOT COVER' to alert the user to the risk of fire that exists if the heater is accidentally covered.

CAUTION - Some parts of this product can become very hot and cause burns. Particular attention has to be given where children and vulnerable people are present.

This appliance can be used by children aged from 8 years and above and by persons with reduced physical, sensory or mental capabilities or lack of experience and knowledge if they have been given supervision or instruction concerning use of the appliance in a safe way and understand the hazards involved.

Children shall not play with the appliance. Cleaning and user maintenance shall not be made by children without supervision.

Children of less than 3 years should be kept away unless continuously supervised.

Children aged from 3 years and less than 8 years shall only switch on/off the appliance provided that it has been placed or installed in its intended normal operating position and they have been given supervision or instruction concerning use of the appliance in a safe way and understand the hazards involved. Children aged from 3 years and less than 8 years shall not plug in, regulate and clean the appliance or perform user maintenance.

Note that due care and consideration must be taken when using this heater in series with a thermal control, a program controller, a timer or any other device that switches on the heat automatically, since a fire risk exists when the heater is accidentally covered or displaced.

If the supply cord is damaged it must be replaced by the manufacturer or service agent or a similarly qualified person in order to avoid a hazard.

WARNING: Servicing and product repairs should only be undertaken by the manufacturers approved service agent or a similarly qualified person, using only exact manufacturer approved spare parts.

WARNING – THIS APPLIANCE MUST BE EARTHED

The electrical installation must be carried out by a competent electrician, and be in strict accordance with the current I.E.E. Regulations for Electrical Equipment in Buildings. The wires in this mains lead are coloured in accordance with the following code:

GREEN AND YELLOW:	EARTH
BLUE:	NEUTRAL
BROWN:	LIVE
BLACK	PILOT WIRE

- see also 'Pilot Wire Connection'

The heater is fitted with a length of flexible cable type H05VV-F size 4 x 1.0mm² for connection to the fixed wiring of the premises through a suitable connection box positioned adjacent to the heater.

A means for disconnection must be incorporated in the fixed wiring of the premises in accordance with the wiring rules. The supply circuit to the heater must incorporate a double pole isolating switch having a contact separation of at least 3mm.

Pilot Wire Connection

The BLACK control wire is designed to carry a signal from a wall mounted Dimplex programmer. If a programmer is not being used, the pilot wire should be isolated in accordance with the current IEE Wiring Regulations.

IMPORTANT - DO NOT connect the BLACK pilot wire to earth. Care should be taken with the installation of the pilot wire(s) as when switching to background (setback) they become energised at 240V although only at a current of less than 100mA. In every case a suitable means of isolation must be provided for the pilot wire and marked to indicate that two sources of supply may be present at the heater. Where pilot wires are installed separately from the heater final sub-circuit they should be protected, double insulated and carry their own integral earth continuity conductor.

Supplementary Earth Bonding

Should Equipotential Earth Bonding be required the earthing conductor in the supply cord is deemed to provide the supplementary bonding connection (see Regulation 544.2.5, 17th Edition I.E.E. Wiring Regulations).

Please note that lit cigarettes, candles and oil burners, combined with the convection effect of electric heaters can cause soot deposits to build up on the surface directly above and to the sides of the heater. This is not a fault of the heater. Extensive burning of candles or smoking in the operating environment of this product can produce heavy discolouration within a few months of use.

General

The heater is designed for wall mounting using the wall bracket supplied. It should only be operated when in the upright position as shown - see **Fig. 1** and **Fig. 2**. All models are splash proof to IP24 standard and may be used in bathrooms, however not in the immediate vicinity of baths, showers, water connections, wash basins or swimming pools. Before connecting the heater check that the supply voltage is the same as that stated on the heater.

Wall Mounting

IMPORTANT – The wall bracket supplied with the appliance must be used. The heater should be positioned observing the minimum clearances stated around the heater - see **Fig. 1** and **Fig. 2**.

DO NOT locate the heater immediately below a fixed socket outlet or connection box.

1. Remove wall mounting bracket from the back of the heater by depressing the spring latch at the top of each bracket - see **Fig. 3**.
2. Fix the wall bracket securely to the wall through the four screw holes provided.
3. Present the heater to the wall bracket, and engage lower slots in the back with bracket.
4. Raise the heater to upright position and push the heater onto bracket to engage top latches.

Dimensions

Model(s)	Watt (kW)	A (mm)
QRAD050	0.50 kW	513
QRAD075	0.75 kW	513
QRAD100	1.0 kW	675
QRAD150	1.5 kW	756
QRAD200	2.0 kW	918

Fig. 1

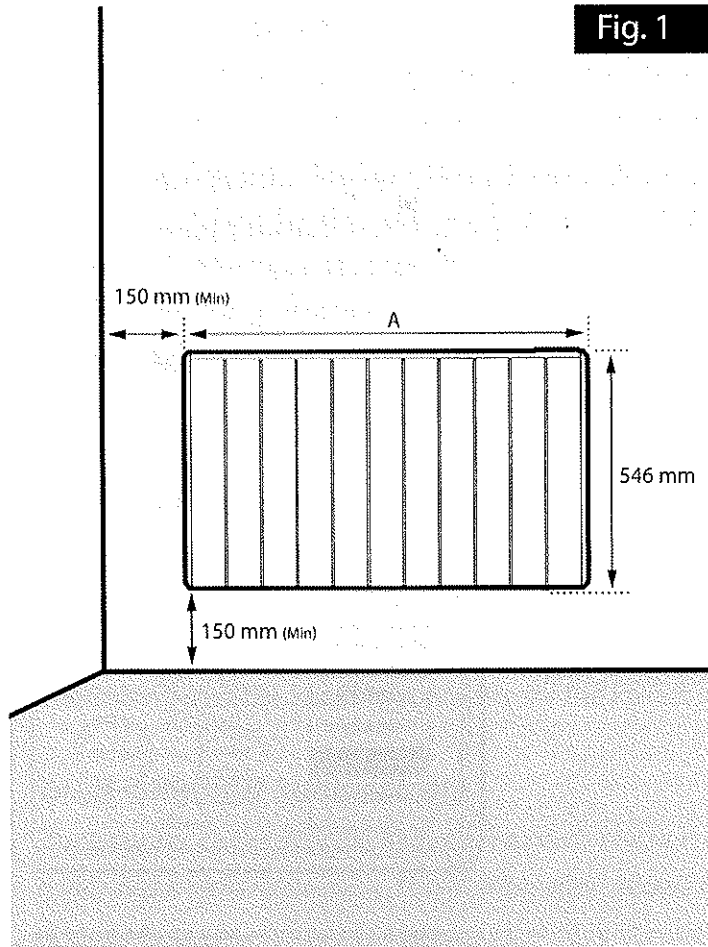

Fig. 2

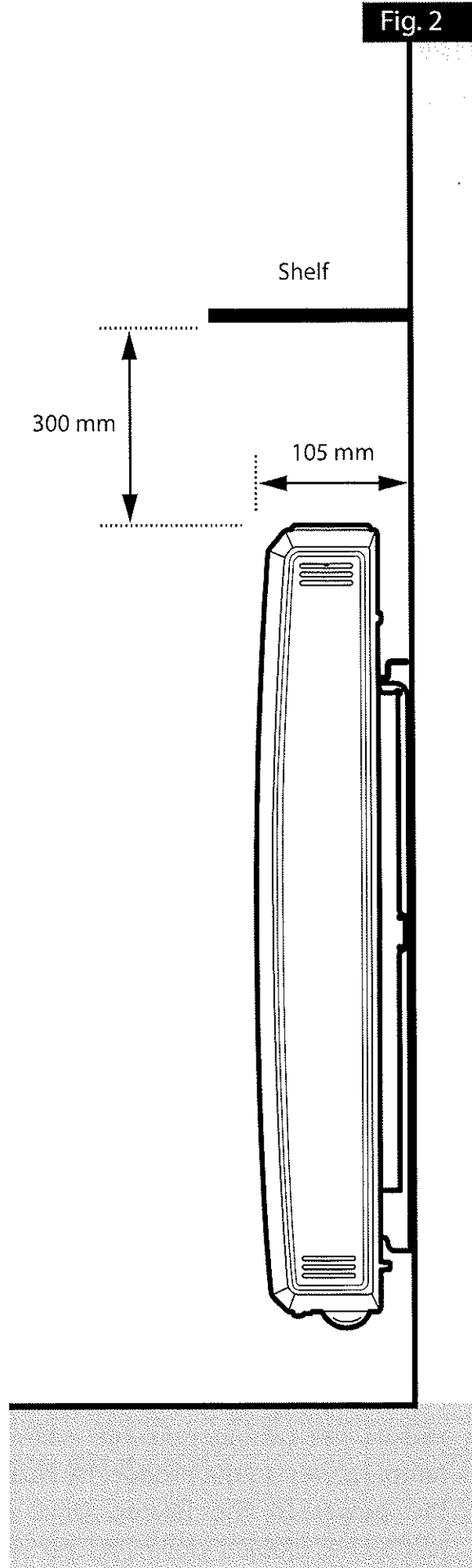
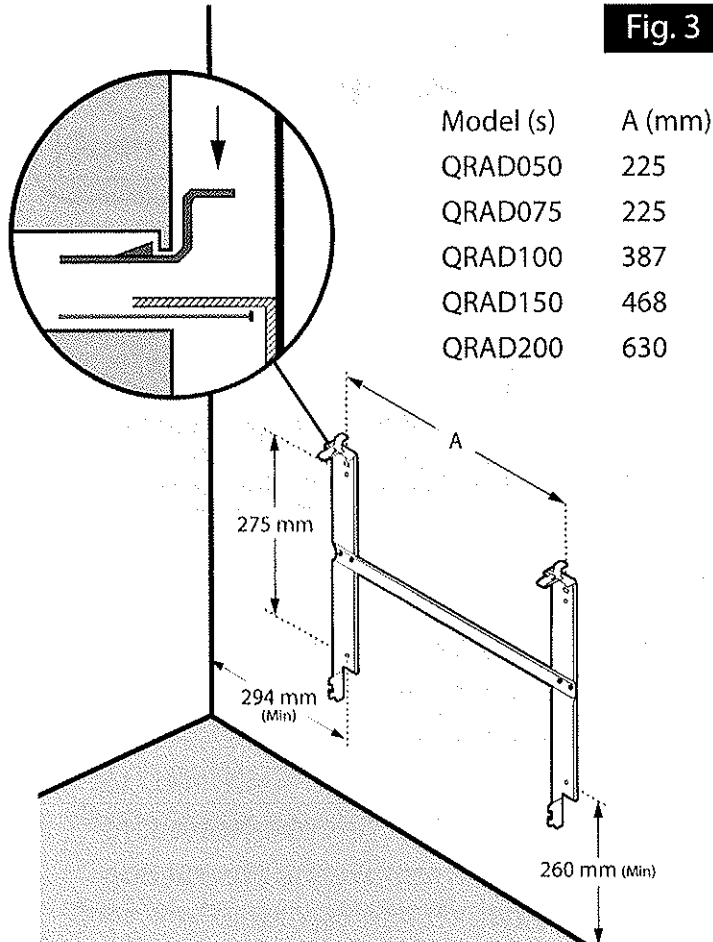

Fig. 3



Notes to the Installer

Test Mode

When the heater is connected via a pilot wire system, the test mode allows the installer to confirm that the heater is responding correctly to the incoming pilot wire signal.

Pilot wire mode must be enabled in the heater's settings in order for the appliance to be controlled by a Dimplex controller with pilot wire connection.

Press **Menu**, **Back** and **Enter** for ten seconds to enter the service menu, select **Pilot Wire** and press **Enter**. Select **Enable**.

The desired comfort temperature should be selected using \wedge and \vee . Press **Enter** to confirm.



Note: The comfort temperature can be changed later if required.

The heater will now enter a test state for four minutes. During this test state the display screen will indicate the pilot wire status. Each pilot wire mode should be verified to ensure correct operation.



Note: Some features are not available while pilot wire mode is enabled.

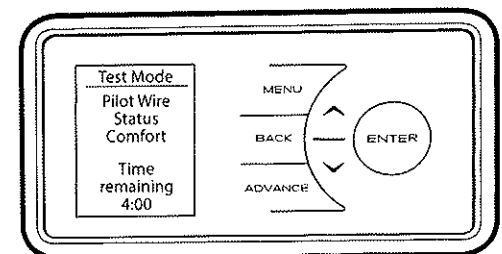
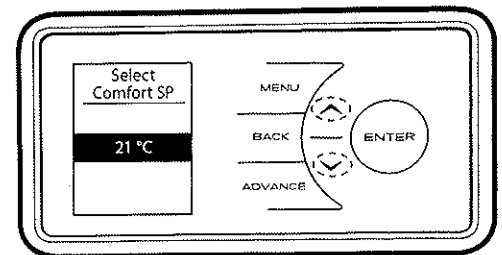
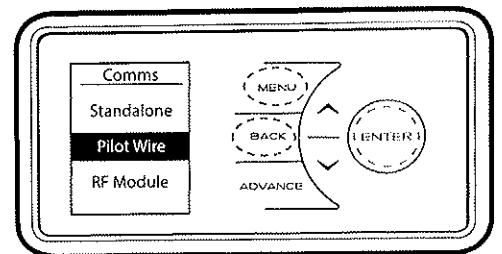

Safety-Overheat protection

For your safety this appliance is fitted with a thermal cut-out. In the event that the product overheats for some reason, the cut-out prevents excessive temperatures on the product by cutting the power to the heater. Once the heater has cooled down, it will reset

automatically, it will continue to cycle on and off automatically until the reason for overheating is removed.

The display screen will flash red to indicate the product has overheated. To reset the display, remove the obstruction and hold **Enter** for 10 seconds.

User introduction

Thank you for choosing the Dimplex Q-Rad Electric Radiator. We manufacture the highest quality heating products for use in a wide variety of environments. This product has been designed to incorporate the latest, most advanced technologies to give you maximum control over your heating. The system allows for the simple setting of required time and temperature, and includes many energy-saving features which work automatically to help keep you warm for less.

Please read the instructions closely before first using the product, there is also quick-start guide on the next page if you need a reminder of how to use the basic functions in the future.

Energy saving features

The Dimplex Q-Rad Electric Radiator has many features which are designed to save you money. It has a self-learning capacity, constantly monitoring the effect that its actions have on the room temperature. This means that your heater knows how long it will take to get to a certain temperature, or when to turn off as it approaches a comfortable temperature. This minimises the energy that it uses whilst maximising comfort, keeping you warm for the lowest possible cost.

Dual-element technology

The Dimplex Q-Rad Electric Radiator has a convection element which can run on half or full power. It also has a radiant element. This combination allows the product to automatically use one or both of these heat sources to maintain an incredibly accurate room temperature. It will reduce its output as the room gets close to the target temperature too, minimising the risk that the room overheats, saving you energy.

Open window technology

Should a window or door be accidentally left open, your heater will detect the sudden change in temperature and go into standby mode, returning to normal operation when the window or door has been closed. This stops the heater from operating while heat is escaping from the room, saving you money.

EcoStart (Anticipatory Control)

Having learnt how quickly it can heat up your room, the Dimplex Q-Rad Electric Radiator is able to turn on at just the right time in order to get the room up to a comfortable temperature when you want it. For example, if you get up at 7am, you would normally have to guess when to turn the heating on in order for it to pre-heat the room in time. Depending on how cold it is outside, this could mean the room is still cold when you have to get out of bed, or mean that its been warm for half an hour before it needed to be. This clever feature means that if you select 21 degrees celsius at 7am, the heater will turn on exactly when it needs to to meet this target, running for shorter periods of time when the weather is mild, and ensuring the room is nice and warm in the winter.

These functions are explained in more detail later, and can be disabled if the environment where the heater is installed means that they are not needed.

Quick Start Guide

This guide is for quick reference only. Please refer to the operating section for further information.

How Does the Heater Control Work?

The control allows you to choose when you want heat and at what temperature.

When using a timer mode (see below), **Comfort On** will display on the home screen to tell you when the heater is maintaining the temperature displayed. **Comfort Off** will display when the heater is outside of a timed heating period.

When **Manual**, **Eco** or **Frost** modes are being used the heater will always maintain the temperature shown on the home screen.

Set the Time

To set the date and time on the heater, press **Menu**, then press the **Enter** with **Time / Date** highlighted. Press \wedge or \vee until the correct value is shown, then press **Enter** to confirm and move on to the next value. Repeat until all details are correct, and **Set** displays, then press **Back**.

The time is automatically adjusted in spring and autumn between Greenwich Mean Time (GMT) and British Summer Time (BST).

Set the Temperature

The temperature shown on the display is the room temperature set point. This is the temperature that the heater will maintain during heating periods. If the room temperature is above this temperature then the heater will not operate. The heater leaves the factory with this temperature set at 21°C which represents a typical, comfortable room temperature. If you require a different room temperature then press either \wedge or \vee on the home screen until the display shows the temperature you require.



Timer Modes

Your Quantum heater comes pre-programmed with four timer modes. These modes define the periods when the heater will operate in **Comfort On** mode. The four modes are:

Timer Mode	Description
Out All Day	6 hours heating per day in two periods
Home All Day	9 hours heating per day in one period
Holiday	Set the number of days for which you are on holiday
User Timer	Customise times in four periods

Child Lock

If you need to lock the controls so that the settings cannot be changed then activate the **Child Lock**. To lock the controls press and hold both the **Back** button and **Enter** for three seconds. **Child Lock** will appear at the bottom of the screen. To unlock the control repeat the action by pressing both the **Back** button and **Enter** for three seconds.

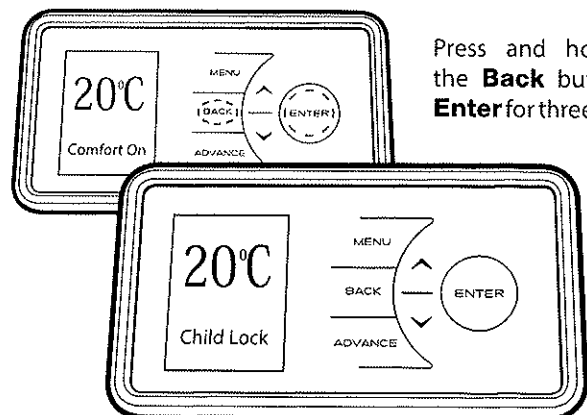

Press and hold both the **Back** button and **Enter** for three seconds

Which Timer Mode is Best for Me?

The heater leaves the factory set in **Out All Day** mode. If you are out during the day and only require heat in the mornings and evenings then this mode will suit your lifestyle and you won't need to alter anything. If you are in during the day then you should select the **Home All Day** mode which is a single heating period. The times of these modes can be modified, or the **User Timer** mode can be used to give you four periods of heating split throughout the day. If you are away for an extended period then you can use the **Holiday** mode. This allows you to reduce the heating during the period that you are away, reverting to the previously selected mode on the day you return.

To choose a timer mode press **Menu** followed by **Enter** to select **Mode** then **Timer Mode**. Select the mode required by pressing \wedge or \vee then **Enter**. For options **Out All Day**, **Home All Day** and **User Timer**, three choices are available - **Select**, **Preview** and **Modify**.

Select - Choose this timer option

Preview - View the times currently set

Modify - Change the times currently set

(Please refer to the operating section of this manual for information on how to modify the programmed times.)

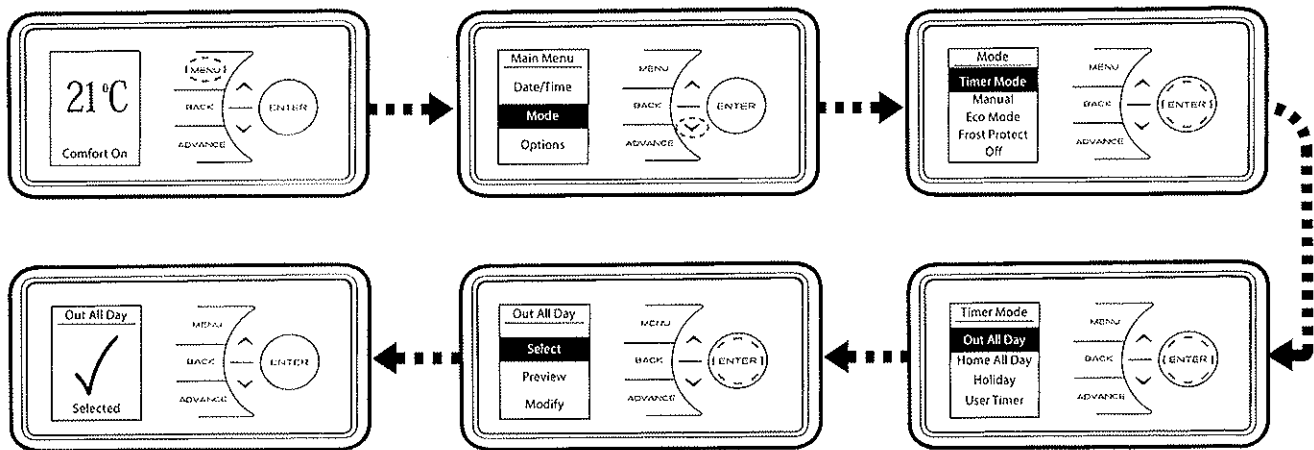

Advance

Sometimes you may be at home when you had not planned to be, or need to leave when you had planned to have the heating on. You can change the way you use your heating temporarily, this temporary change is achieved by using the **Advance** function.

When a timer has been selected, the **Advance** function allows you to begin the next **Comfort On** period early. If the heater is in a **Comfort Off** period and you want heat – press the **Advance** button. If the heater is in **Comfort On** and you don't want heat, press the **Advance** button and it will go off until the beginning of the next **Comfort On** period.

Advance Boost

The **Advance** button is also used to give a **Boost** which provides temporary heating for one, two, three or four hours. Press the **Advance** button twice to begin a one hour **Boost**. Continue pressing the **Advance** button to enter the longer **Boost** periods.

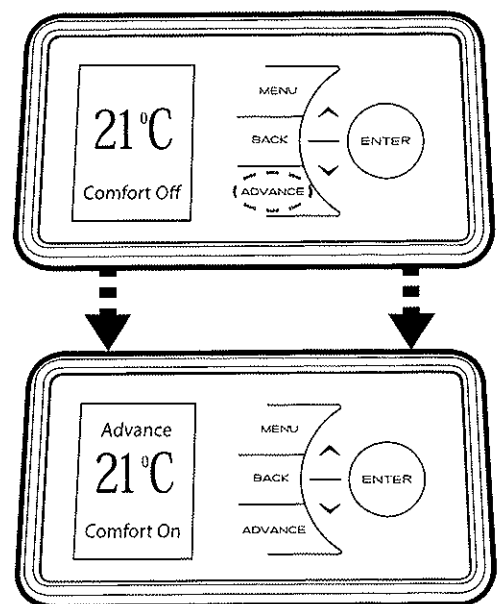

Operation

The controls are located on the top right of the heater. The heater is fitted with an adjustable electronic controller consisting of a display screen and six touch sensitive buttons.

- ① Display Screen
- ② 'Menu' Button
- ③ 'Back' Button
- ④ 'Up and Down' Arrows
- ⑤ 'Enter' Button
- ⑥ Heating Status
- ⑦ 'Advance' Button

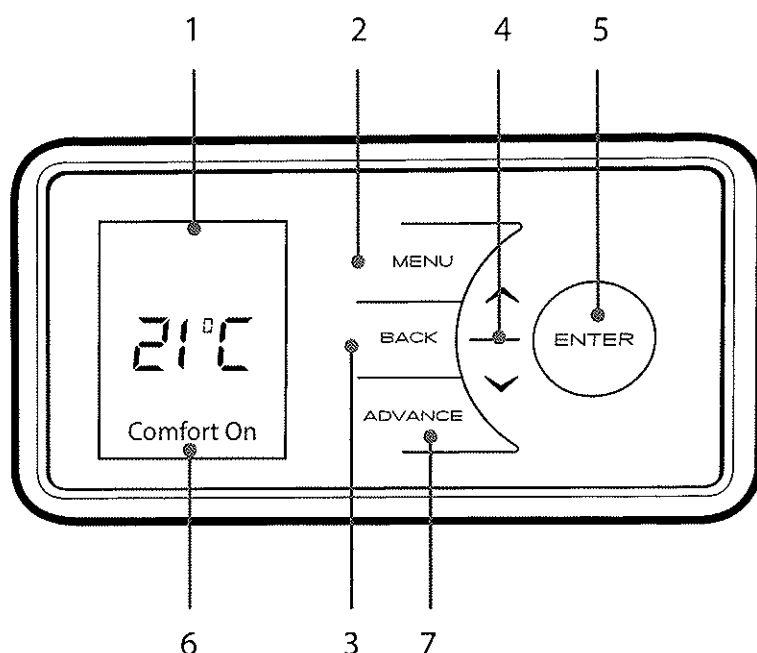

The heater is fitted with an adjustable thermostat enabling the room temperature to be controlled. The **minimum** room temperature is 7°C. The **maximum** temperature is set to 26°C by default however this can be increased to 32°C if required. A temperature of 21°C represents a **normal** room temperature.



NOTE: Should the heater fail to operate, this may be due to the room temperature being higher than the thermostat setting.

Control Functions

The heater controls can be easily adjusted by using the six buttons on the User Interface.

1. The **Display Screen** shows the options available at each stage of adjustment.
2. **Menu** – displays the main options list;
Date/Time – Set the date and time.
Mode – Set the mode of operation.
Options – Temperature units, daylight savings time, lock settings and service information.
3. **Back** returns to the previous programming stage.
4. The **UP** and **DOWN** buttons are used to navigate through the menus and alter setting values. The **Up** and **Down** button are also used to adjust the required room temperature on the main screen. The screen colour changes based on the temperature selected, showing deep blue through to bright red.
5. **ENTER** is used within the menu options to confirm settings. On the main screen pressing **Enter** will display the enabled features.
6. The timed periods during which the heater is providing heat are defined as '**Comfort On**' (this is displayed at the bottom of the screen).

Outside of heating periods the heater will not deliver heat and these periods are called '**Comfort Off**'.

While constant heat modes are active, the mode of operation is displayed at the bottom of the screen e.g. '**Manual**'.

7. The **ADVANCE** button overrides the heating settings and changes the operational state of the heater. If a timer mode is active, pressing **Advance** will cause the heater to remain ON until the next OFF period is due, or OFF until the next ON period is due.

If the heater is in a constant mode of operation, **Advance** can be used to switch the appliance ON and OFF.

Advance is also used to enter **Boost** mode. **Boost** mode delivers heat for between one and four hours.

Main Screen

After 30 seconds of inactivity the heater will default back to the **Main Screen**. Here the chosen temperature is displayed along with the mode of operation. Any use of the **Advance** function will be displayed here, and pressing **Enter** will show the functions which are enabled.

When left inactive for a long period of time this display will 'sleep' and the text will disappear. Press any button for its return.

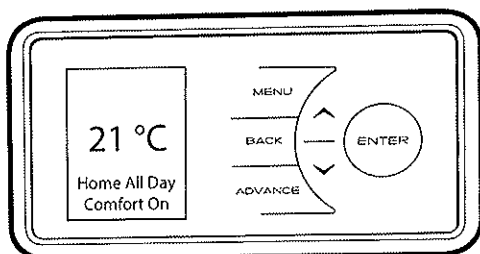

NOTE: The display screen will return to the main screen after a period of 30 seconds of inactivity.

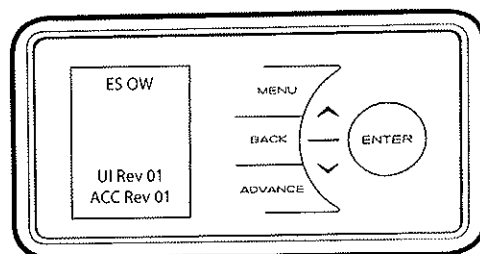

NOTE: Pressing ENTER will show the functions which are enabled, e.g. ES and OW above. Ref: page 7.

Setting the Date and Time

The heater incorporates a real time clock with calendar function. The time clock has a battery backup that will keep the clock running in the event of a mains power outage.

To adjust the time or date follow the steps below.

Press the **Menu** button. Select **Date/Time** by pressing the **Enter** button. Press \wedge and \vee to select the correct day of the month and press **Enter** to select.

Repeat this operation, until the date and time has been set, ensuring to press **Enter** to select. Press **Back** button to return to the **Main Screen** once **Set** has been displayed.

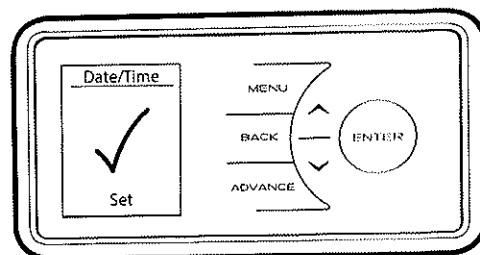
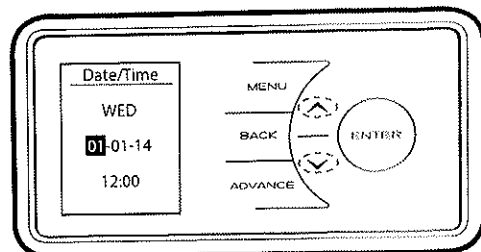
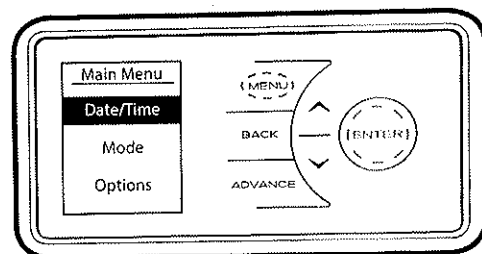

Modes of Operation

The heater comes pre-programmed with a set of heating profiles. There are four options available - three preset and one user adjustable timer;

1. **Out All Day** (pre-programmed) - has the following preset times Monday to Sunday, which can be altered if desired;
07.00 until 08.30
17.30 until 22.00
2. **Home All Day** (pre-programmed) - has the following preset times Monday to Sunday, which can be altered if desired;
08.00 until 21.00
3. **Holiday** (pre-programmed for 7 days at 10°C) - set the number of days required (from 1 to 300) and the temperature required. 7°C is advised if you just want to protect the property from frost while you are away.
4. **User Timer** - provides greatest flexibility to the user. Four time slots are available throughout the day and these can be customised for each day of the week.



NOTE: Once modified a programme must be selected if you want to begin using it.

The heater can also maintain a constant room temperature using the following modes;

1. **Manual** mode heats the room to a comfortable temperature of 21°C.
2. **Eco** mode maintains a room temperature of 18°C. By reducing the room temperature slightly, significant energy savings can be achieved. The green display colour indicates that selected temperature provides a comfortable room temperature while reducing energy consumption.
3. **Frost Protect** mode maintains a room temperature of 7°C. This mode should be used to provide protection against frost as indicated by the blue display.



NOTE: It is recommended that the timer is used as doing so can reduce the running cost. Operating the appliance in the permanent heating modes may result in increased running costs.

Select **Off** to switch off the appliance. This mode should be used when heating is not required for extended periods. Press any of the buttons to activate the display and then select the required mode of operation.



NOTE: In all modes, \wedge and \vee can be used to adjust the required room temperature. In timer modes, this change is temporary and the heater will revert the saved heating profiles at the end of the **Comfort On** period.

Choosing and Setting a Mode

Timer Modes

To choose a timer mode press **Menu** and \downarrow to select **Mode**, then press **Enter**. Now select **Timer Mode**, again using the **Enter** button. Select the mode required, by pressing the \wedge or \vee and **Enter** buttons.

For options **Out All Day**, **Home All Day** and **User Timer**, three choices are available - **Select**, **Preview** and **Modify**.

- **Select** - choose this timer option.
- **Preview** - view the times currently set.
- **Modify** - change the times currently set.

When **Modify** is chosen, select and change each option using the \wedge , \vee and **Enter** buttons. At the end of each period, select **Next** to move to the following period. When a day is complete select **Save** to update it.

Once the first day has been set up it is possible to copy these settings to successive days or all days by either choosing **Copy Next** or **Copy All**.

If preferred each day can be modified individually and saved. It is also possible to **Clear** each day or **Clear All** days. Options are;

- **Save** - save times for one day.
- **Copy Next** - copy times to following day.
- **Copy All** - copy times to all seven days.
- **Clear** - zero all times that day.
- **Clear All** - zero all times for all seven days.

To select a mode, choose **Select** and press **Enter**.

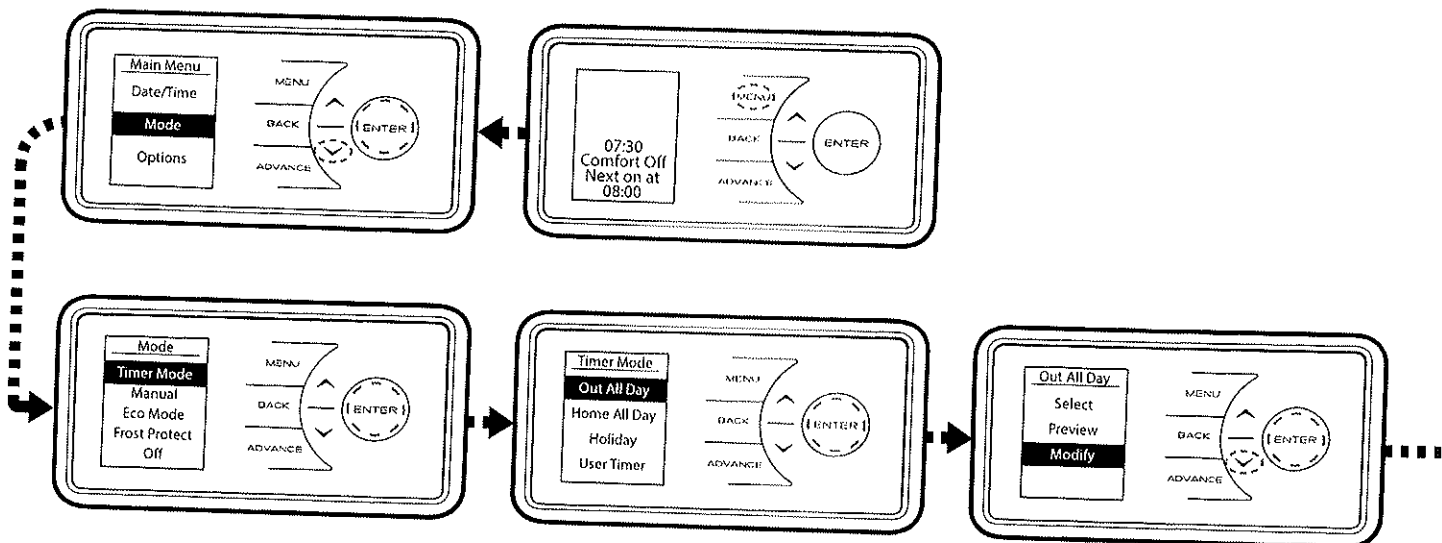

If EcoStart control is disabled, the heater will not operate until the beginning of the heating period. This should be taken into consideration when setting the heating periods (See note below and page 17).

In **Holiday** mode the number of days that the room will be unoccupied can be adjusted together with the required room temperature.

Press \wedge and \vee to choose a holiday period between 1 and 300 days, then press the **Enter** button.

Press \wedge and \vee to choose a temperature to be maintained during this period and press the **Enter** button. At the end of the holiday mode the heater will automatically revert back to the previously selected programme.

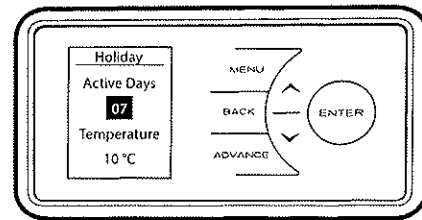

Constant Heat Modes

To choose a constant heat mode press **Menu** and \vee to select **Mode** and press **Enter**. Then select the required mode, again using the **Enter** button.



NOTE: If **EcoStart** (ES) is enabled the heater will begin heating the room before the start of the heating period to ensure the room is at the required temperature when the period starts. If disabled the heater will simply start heating at the start of the **Comfort On** period.

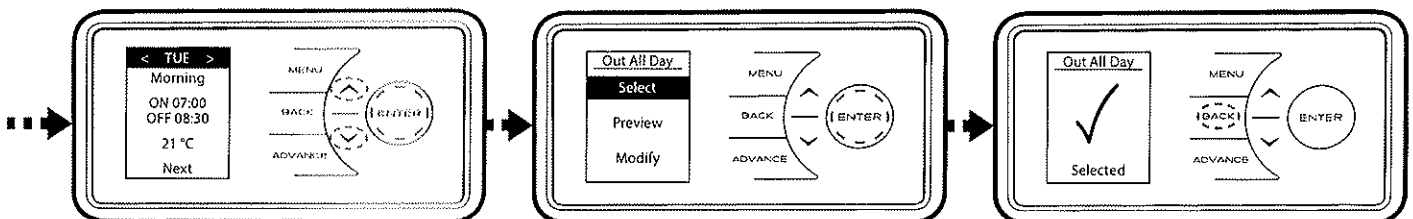

Advance

The **Advance** function allows the heating profile of the appliance to be changed temporarily. When a timer has been selected, the **Advance** function is used to begin the next **Comfort On** mode early. If the heater is in **Comfort Off** mode and heat is required, press the **Advance** button.

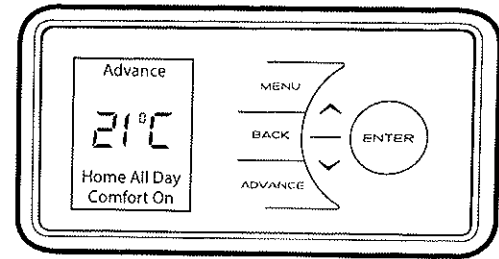

If the heater is in **Comfort On** and heat is not required, press the **Advance** button and the heater will turn off until the beginning of the next **Comfort On** period. If the heater is in **Manual, Eco Mode** or **Frost Protect** mode pressing the **Advance** button will switch off the heater. The heater will remain off until the **Advance** button is pressed again.

Boost

The **Advance** button is also used to enter the **Boost** mode which provides temporary heating for one, two, three or four hours. Press the **Advance** button twice to begin a one hour **Boost**. Continue pressing the **Advance** button to set longer **Boost** periods.

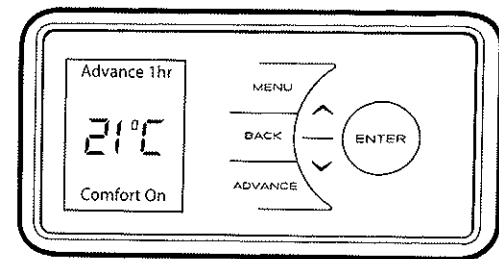

Options

The **Options** menu allows the settings to be modified to suit the user's preferences. These are;

DST Rule - Select your daylight saving setting. The heater clock will automatically adjust for daylight saving or "British Summer Time" as it is often referred to. If no adjustment is required then select none.

Auto Lock - Enable or disable the **Auto Lock** feature. This feature locks the interface if left inactive for longer than one minute. To unlock the appliance, press and hold **Enter** for two seconds.

Sound - Audio feedback can be enabled or disabled.

Service Info - Service information is displayed.

Temp Units - Choose whether your unit displays degrees centigrade or Fahrenheit.

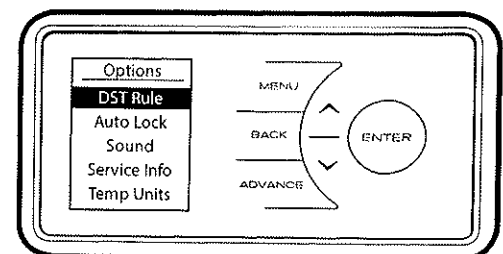

Child Lock

To lock the controls press **Back** and **Enter** for three seconds. **Child Lock** will appear at the bottom of the screen. To unlock the control repeat the action of pressing **Back** and **Enter** for three seconds.



NOTE: The controls cannot be adjusted when child lock is active.

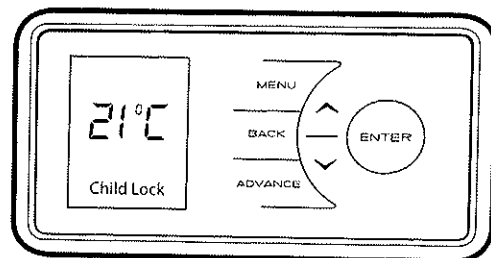

User Information

Press and hold **Enter** for five seconds to display the **User Information** menu;

SP Range (set point) allows adjustment of the maximum temperature.

Open Window detection (OW). When enabled the appliance will reduce the target room temperature to limit the energy wasted when a window is opened.

Occupancy detection (OD) reduces the room temperature when the room is unoccupied. **Note:** currently not available on this model.

EcoStart (ES) – to achieve the desired temperature at the onset of the timed **Comfort On** period the appliance anticipates when it needs to start heating prior to the onset of the timed 'on' period. E.g. room is 16°C, with 21°C at 7am set on the timer. With ES on the control will start to heat the room before 7am, reaching 21°C at this time. With ES off the heater will start to heat the room at 7am and will reach 21°C after this time.

Factory reset returns all settings to the factory presets.



NOTE: Open Window detection is enabled by default. EcoStart is disabled by default.

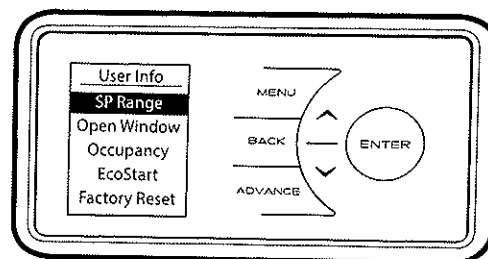

Energy Saving Tips

The energy we use to heat, light and power our homes contributes over a quarter of the UK's carbon emissions, the principle contributor to climate change.

Around half the energy used in the home is for heating and hot water, so using your heating system efficiently will not only help the environment, but also save you money.

Energy efficiency tips for heating and hot water

1. Don't set the temperature to high...

Reducing the thermostat setting by just 1°C can reduce your energy use by as much as 10%. If you're going away during the winter, leave the thermostat on the frost protection setting to provide protection from freezing at minimum cost.

2. Use it where you need it...

Set the appropriate temperature on your heaters for the room they are in; for example, leave the thermostat on a heater in a spare bedroom on a lower setting.

3. Use it when you need it...

Use heaters fitted with timers or linked to central controllers to turn the heating on only when you need it and automatically switch it off when you don't.

4. Curtains

Close your curtains at dusk to stop heat escaping through the windows.

5. Windows

Nearly 25% of heat loss can occur through poorly insulated frames and single glazing. If you can't afford to double glaze all your windows, go for the rooms you heat most.

6. Treat your hot water tank...

give it a jacket An insulating jacket for hot water tanks costs only a few pounds and pays for itself within months. Fit one that's at least 75mm (3") thick and you could save £10-15 a year.

7. Water

Use a shower if you have one to save time, money and water. Don't set the thermostat too high on your water heater - 60°C/ 140°F is usually adequate for bathing and washing. Put the plug in when running hot water in your sink - leaving hot taps running is both wasteful and expensive. Ensure dripping taps are repaired quickly. In just one day, you could waste enough water to fill a bath.

Other energy saving tips for around the home

1. Lights

Turn off lights whenever you leave a room for more than ten minutes. Use low-energy bulbs wherever you can as they use less than a quarter of the electricity used by ordinary light bulbs and last ten times longer!

2. Cooking

Use the right size pan for food and cooker hob. Keep saucepan lids on - this enables you turn down the heat. Boil water for cooking in a kettle first.

Important

During the initial operation, some odour may be noticed due to the newness of materials used in manufacture. This is normal and will disappear after a short period of use. It is however advisable to keep the room well ventilated.

Cleaning

WARNING - ALWAYS DISCONNECT FROM THE POWER SUPPLY BEFORE CLEANING THE HEATER.

Before commencing cleaning, disconnect the electricity supply to the appliance and allow it to cool. The outside can be cleaned by wiping it over with a soft damp cloth and then dried. Do not use abrasive cleaning powders or furniture polish, as this can damage the surface finish. To release the heater from the wall bracket for cleaning or redecoration, depress the latch on both brackets (See Fig. 3, page 5) and hinge forward.

Recycling



For electrical products sold within the European Community. At the end of the electrical products useful life it should not be disposed of with household waste.

Please recycle where facilities exist. Check with a Local Authority or retailer for recycling advice in your country.

After Sales Service

If this product appears damaged when first received or does not function correctly contact us by e-mail at aftersales@dimplex.co.uk or call 0844 879 3588. For ROI please call 01 842 8222.

Do not return the product in the first instance as this may delay us providing you with a satisfactory service. ACCIDENTAL DAMAGE IS NOT COVERED UNDER THE WARRANTY.

Your product is guaranteed for two years from the date of purchase. Within this period we undertake to repair or exchange this product free of charge provided it has been installed and operated in accordance with these instructions.

Should you require assistance with this product please go to www.dimplex.co.uk and click on "Customer Support" or e-mail us at aftersales@dimplex.co.uk

Alternatively call our contact centre on 0844 879 3588 (UK only). This is a Lo-call number from a BT Landline - other providers including mobile phones may charge you more. For ROI please call 01 842 8222.

To assist you, we need the following information: model number and product ID (these are found on the back of the appliance), nature of the fault and date of purchase. **Please retain your receipt as proof of purchase.** Your rights under this guarantee are additional to your statutory rights, which in turn are not affected by this guarantee.

Patent/Patent Application

This product is protected by one or more of the following patents or patent applications:

Great Britain: GB1304025.8

International: PCT/EP2014/054404

CE This product complies with the European Safety Standards EN60335-2-30 and the European Standard Electromagnetic Compatibility (EMC) EN55014, EN60555-2 and EN60555-3. These cover the essential requirements of EEC Directives 2006/95/EC and 2004/108/EC

Dimplex[®]
A world of expertise

Millbrook House
Grange Drive
Hedge End
Southampton
SO30 2DF

Customer Helpline: 0844 879 3588
Fax: 0844 879 3583
Email: aftersales@dimplex.co.uk
Website: www.dimplex.co.uk

© GDC Group LTD. All rights reserved. Material contained in this publication may not be reproduced in whole or in part, without prior permission in writing. A division of the GDC Group LTD, Millbrook house, Grange Drive, Hedge End, Southampton SO30 2DF.